

BR 083 085 ClassicLine body safety shower, ceiling mounted

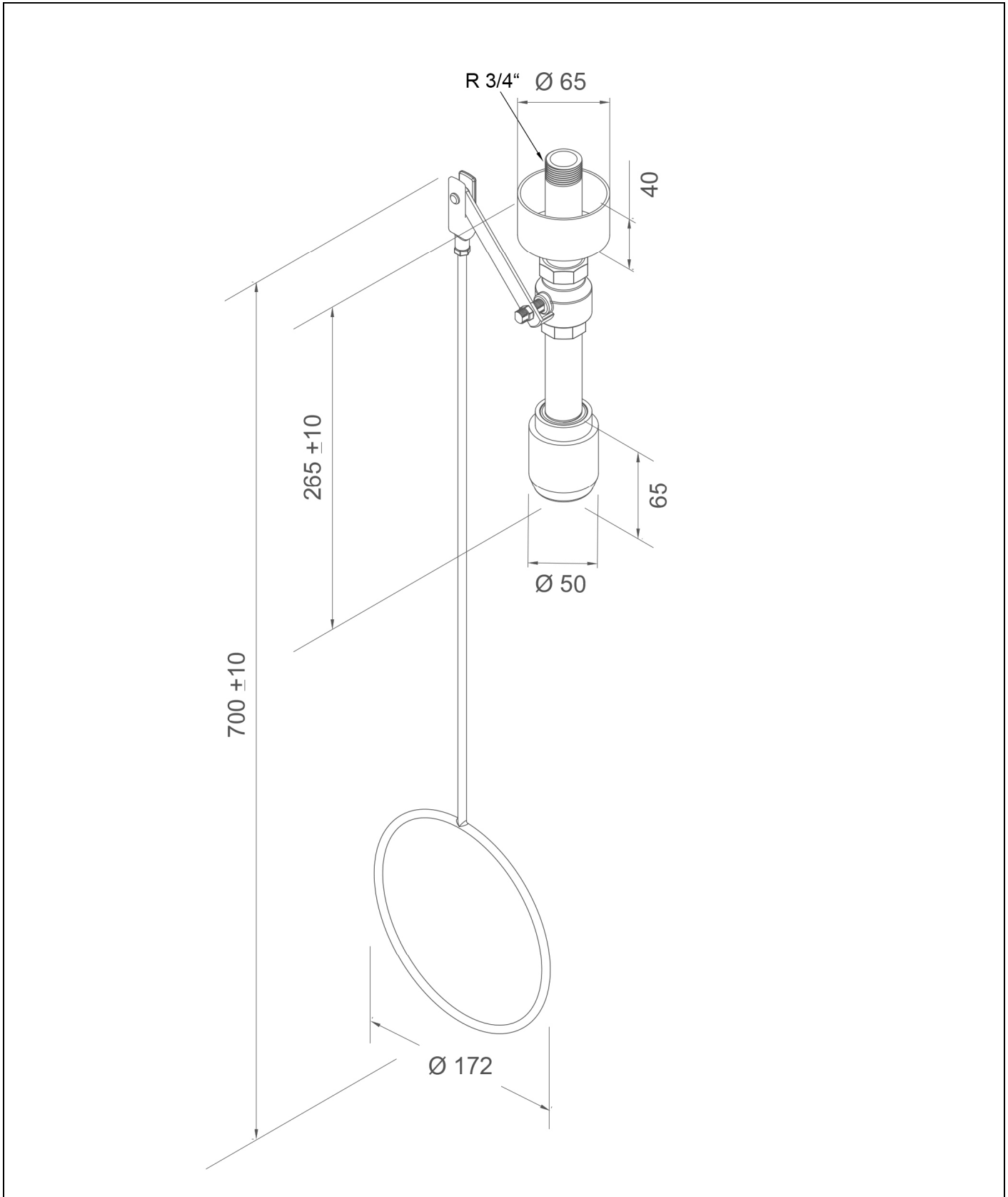

Technical description
<p>ClassicLine body safety shower, ceiling mounted</p> <ul style="list-style-type: none"> - connection pipe 3/4" of stainless steel, chemical resistant green powder coated, length 75 mm, water inlet 3/4" male - push-on rosette of polyamide to cover the installation - ball valve 3/4" made of dezincification-resistant brass, with pull rod actuation, DIN-DVGW tested and certificated - pull rod with ring handle of stainless steel, chemical resistant green powder coated, length 700 mm - ceiling shower arm 3/4" of stainless steel, chemical resistant green powder coated, headroom 265 mm - integrated automatic flow regulation 50 l/min. for a spray pattern acc. to the norms at a specified operating range of 1.5 to 3 bar dynamic water pressure - high-performance shower head of chemical resistant plastics, black, with improved spray pattern, corrosion resistant, largely calcification- and maintenance-free, very robust, self-draining - sign for body safety shower according to EN ISO 7010 und ASR A1.3, self-adhesive PVC-film, 150 x 150 mm, viewing distance 15 metre - mounting height 2465 mm (± 100 mm) - according to BGI/GUV-I 850-0, DIN 1988 and EN 1717 - according to ANSI Z358.1-2014, EN 15154-1:2006 and EN 15154-5:2019 - DIN-DVGW tested and certificated <p>Manufacturer: B-SAFETY or equal Article-No.: BR 083 085</p>

Technical specifications
Material: stainless steel, plastic
Color: green, black
Headroom: 265 mm
Installation height: 2465 mm (± 100 mm)
Operating pressure: 1.5 to 3 bar
Flow rate: 50 l/min
Water inlet: 3/4" male







Norm conformity	Approvals
- EN 15154-1:2006	- DIN-DVGW, DVGW, NW-0416CL0425
- EN 15154-5:2019	- GOST-R, Zertifikats-Nr. 0615463
- ANSI Z358.1-2014	

Material-overview	Material	Material description
High-performance shower head:	plastic POM	-
Ball valve:	Dezincification-resistant, DZR brass	CW724R
Flow regulator:	plastic POM	-
Piping:	stainless steel	AISI 304
Pul rod with ring handle:	stainless steel	AISI 201
Push-on rosette:	plastic polyamide	-
Sign for body safety shower:	PVC-foil	-

www.b-safety.com

Product overview	
BR 083 085	ClassicLine body safety shower, ceiling mounted - flow rate 50 l/min (hazard class I according to EN 15154-5:2019)
BR 083 085 / 75L	ClassicLine body safety shower, ceiling mounted - flow rate 75 l/min / 20 GPM (hazard class II according to EN 15154-5:2019)
BR 083 085 / 110L	ClassicLine body safety shower, ceiling mounted - flow rate 110 l/min (hazard class III according to EN 15154-5:2019)

Accessories for body safety showers

Product overview	Model	Material	Water inlet	Water outlet	Article-No.
	ClassicLine cable actuation for injured persons lying on the ground, additional to pull rod.	Stainless steel rope	-	-	BR 082 200
	ClassicLine disability friendly pull rod with double ring handle, green. Length: 1150 mm	Stainless steel	-	-	BR 082 300
	PremiumLine disability friendly pull rod with double ring handle, stainless steel. Length: 1150 mm	Stainless steel	-	-	BR 082 350
	Service shut-off for eye showers and safety showers with removable release lever.	Stainless steel	3/4" female	3/4" female	BR 830 955
	Thermostatic mixing valve for eye showers and safety showers, setting range 20 - 43°C, scald protection 43°C, volume flow approx. 60 l/min at 2 bar flow pressure.	Brass	3/4" male and 1" male	3/4" male and 1" male	BR 710 950
	Flow switch for eye showers, protection degree IP 65, electrical supply with 1.5 m cable.	Brass	3/4" female	3/4" female	BR 710 800
	Switch for body safety shower, complete pre-mounted on shower, for EX-Zones 1 & 2.	Plastic	-	-	BR 830 400
	ClassicLine alarm system for eye showers & safety showers with siren-/flashlight combination. Prewired junction box inclusive electronic switch. Electrical supply: 230 V - 50 Hz	Plastic	-	-	BR 015 800